



Important Safety Instructions

To reduce the risk of injury or damage, keep these safety precautions in mind when setting up, using and maintaining your robot vacuum cleaner:

- Read all safety and operating instructions before operating your robot.
- Retain the safety and operating instructions for future reference.
- Pay attention to all warnings on your robot, battery, charging dock and in the user manual.
- Follow all operating and use instructions.
- The external flexible cable or cord of the power supply unit can not be replaced; if the cord or plug is damaged, the power supply unit shall be disposed of.
- This product is designed to be plugged into a standard outlet only. Product may not be used with any type of power converter. Use of power converters will immediately void the warranty.
- **CAUTION:** Only charge one of the following robot batteries: maximum 14.4V, max 2600mAh Ni-MH or maximum 2600mAh Li-ion battery. Other type of batteries may burst causing injury. Always contact Customer Care for the correct replacement of your battery.
- Always charge and remove the battery from your robot and accessories before long-term storage or transportation.
- The battery must be removed from this device before this device is disposed of. To remove the battery from this device, first remove the screws on the bottom, then remove the main PCB and unscrew the battery cover by using a screwdriver. Remove the battery by disconnecting the quick connector.
-  **WARNING:** Chemical Exposure: If the battery pack is leaking, do not allow the liquid to come in contact with skin or eyes. If contact has been made, wash the affected area with copious amounts of water and seek medical advice. Place the battery (the used battery pack included when the robot will be disposed) in a sealed plastic bag and dispose of safely according to local environmental regulation.
-  **WARNING:** Fire or Explosion Hazard: Do not crush or dismantle battery packs. Do not heat or place the battery pack near any heat source or direct sunlight. Do not incinerate or short-circuit the battery pack. Do not subject batteries to mechanical shock.
- Contact your local waste management authority for battery recycling and disposal regulations in your area.
- Your robot is not a toy. Do not sit or stand on robot. Children and pets should be supervised when your robot is operating.
- Robot is for indoor use only.
- Do not use non-rechargeable batteries. Use only the rechargeable battery supplied with the product. For replacement, purchase identical robot battery or contact robot Customer Care for alternative battery options.
- Store and operate robot in room temperature environments only.
- Do not spray or pour liquids on your Robot.
- Do not use any other power supply cord. For replacement cords, please contact Customer Care to ensure proper selection of country specific power supply cord.
- Do not use robot to pick up sharp objects, glass, or anything that is burning or smoking.

- Do not immerse the battery pack in any liquid.
- Do not use robot to pick up spills of water bleach, paint, or other chemicals, or anything wet.
- Before using robot, pick up objects like clothing, loose papers, pull cords for blinds or curtains, power cords, and any fragile objects. If robot passes over a power cord and drags it, there is a chance an object could be pulled off a table or shelf.
- If the room to be cleaned contains a balcony, a physical barrier should be used to prevent access to the balcony and ensure safe operation.
- Do not place anything on top of your robot.
- Be aware that the robot moves on its own. Take care when walking in the area that the robot is operating in to avoid stepping on it.
- Do not operate the robot in areas with exposed electrical outlets in the floor.
- Do not use this device on an unfinished, unsealed, waxed or rough floor. It may result in damage to the floor and this device. Use only on hard floor surfaces or low pile carpet.
- This device has been designed to be used on floors without scratching them. We still recommend that you test this device on a small area of the room to be cleaned to ensure no scratches are made before cleaning the whole room.

Battery and Charging Information

Lithium-ion Battery

Important: Lithium-ion batteries and products that contain Lithium-ion are subject to stringent transportation regulations. If you need to ship this product (with the battery included) for service, travel or any other reason, you **MUST** comply with the following shipping instructions:

- Remove the Lithium-ion battery from the product.
- Place a piece of tape over the battery' s metal charging contacts.
- Reinstall the battery (with the tape on it) in the product and secure the battery door.
- Package the product in its original packaging or in your own packaging that prevents any movement during transportation.
- Ship via ground transportation only (no air shipping).

Battery Storage

If storing robot off the charging dock, remove the battery first. Then store robot and the battery in a cool, dry place.



The symbol on the product or its packaging indicates:

Do not dispose of electrical appliances as unsorted municipal waste, use separate collection facilities. Contact your local authority for information regarding the collection systems available. If electrical appliances are disposed of in landfills or dumps hazardous substances can leak into the groundwater and get into the food chain, damaging your health and well-being. Please contact your local or regional waste authority for more information on collection, reuse and recycling programs.

1. About Your Robot

1.1 Robot

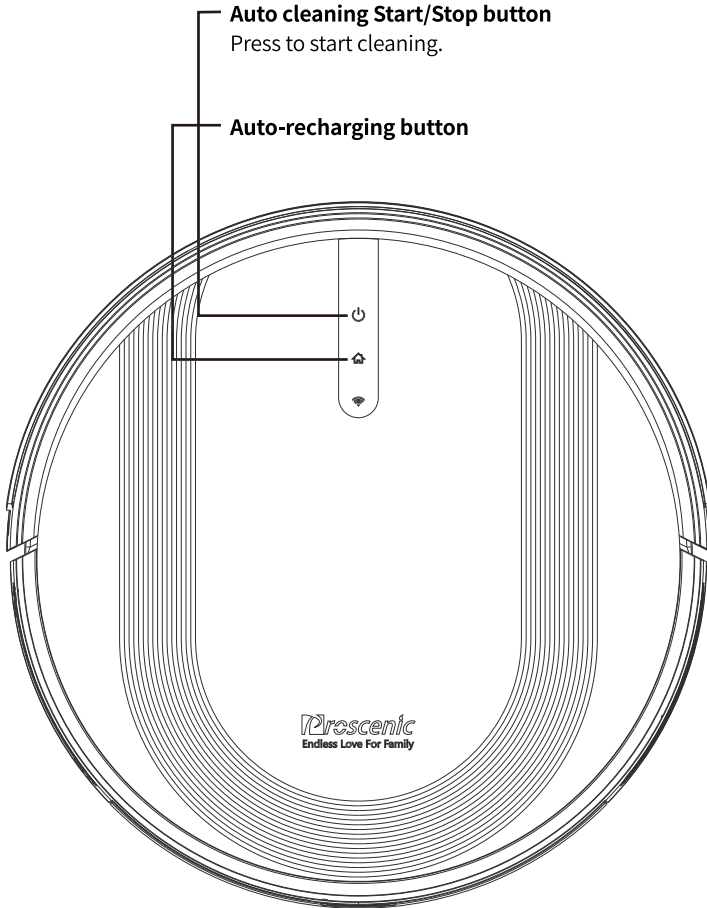

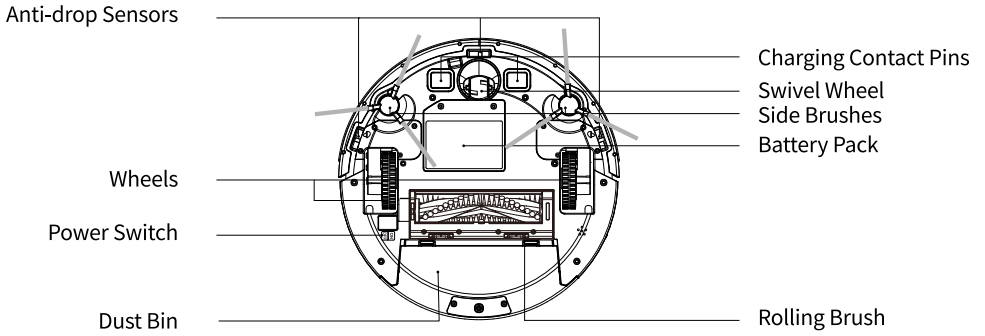

1.2 Charging Dock

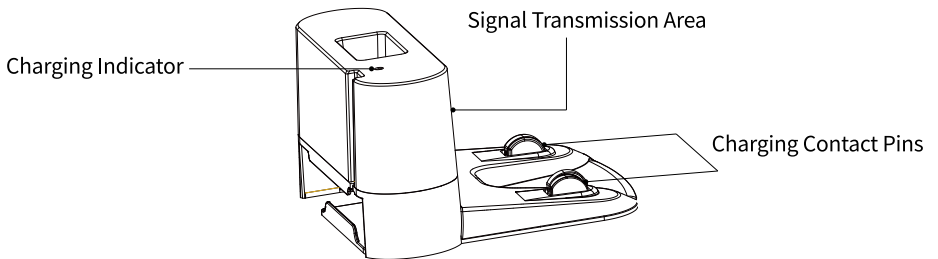

1.3 Remote Control

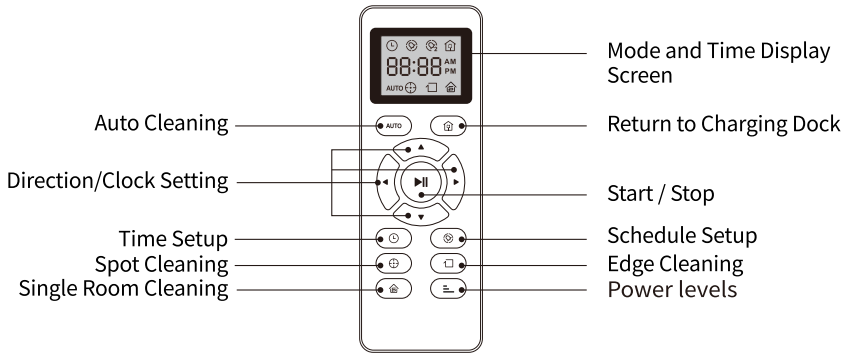

Install 2 AAA batteries before using the remote control for the first time. Make sure the positive and negative ends are facing the correct polarity direction as marked in the battery compartment. When using the remote control, please aim at the robot and the effective distance is 0-5m.

1.5 LED Indicator

LED light	Status
Start/Stop Button Recharge Button	<p>Solid blue light: Normal working/pause/standby</p> <p>Blue light flash: is powering on/upgrading firmware</p> <p>Yellow light flash: low battery/recharging</p> <p>Green light flash: charging</p> <p>Solid green light: Fully charged</p> <p>Red light flash quickly: Abnormal/Error</p> <p>Light off: Off/sleep</p>
WIFI indicator light flash slowly	Configuring network
Solid white light of WIFI indicator light	Successful network configuration

2. Using Your Robot

2.1 Quick Start

1. Plug in the charging dock, and take the rest wire into the trunking at the bottom of charging dock.

Note: If you don't put the rest wire into the trunking, it may stuck the robot while charging or cleaning.

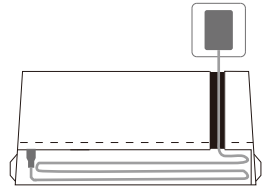

2. Charging Dock Position

1) Place the charging dock on a hard, level surface and against a wall.

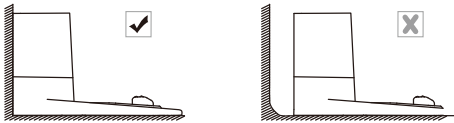

2) Place the charging dock again the wall and make sure the place is open & uncluttered area leaving at least.

- 2 meters (6.5 feet) in front of the charging dock; 1 meter (2.3 feet) on both sides of the charging dock.

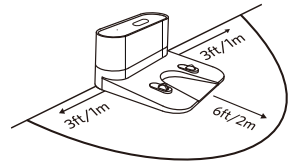

3) Connect the round connector of the adapter into the power socket on the charging dock and the other end into a wall outlet.

Note: Please make sure the the indicator light is on when the charging dock is plugged in, otherwise the robot can not be charged.

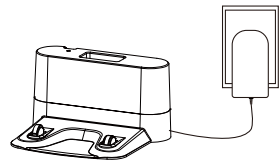

3. Install Side Brushes

Attach side brushes to the bottom of robot by pressing a brush into each slot.

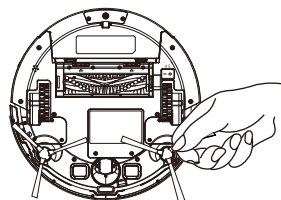

4. Turn on the main power switch on the bottom of robot.

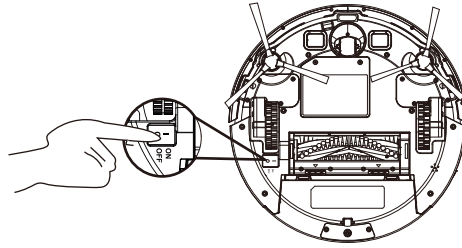



5. Activate the Robot

Place robot onto the charging dock, making sure the metal charging contacts on the charging dock match up with those underneath the robot.

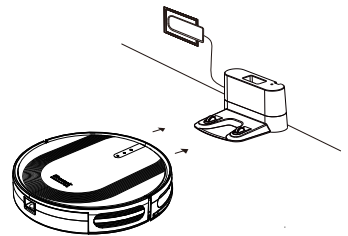
If successful, you will hear a series of tones.





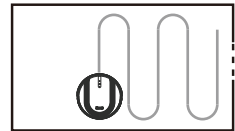
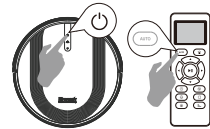

6. Start Cleaning Cycle

- Press the  power button once to wake up the robot.
- Press the  power button again or press the  button on remote control to start a cleaning cycle.



7. Pause

- To pause the robot during a cleaning cycle, press the  button or press the  button on remote control.
- To start the robot, press the  button or press the  button on remote control.

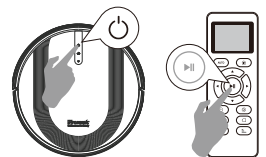

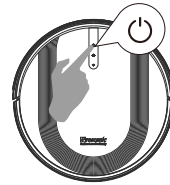

8. Power OFF

- To end the cleaning cycle and put robot in standby mode, press and hold  button until robot indicators turn off.



2.2 How Robot Clean Your Home

1. Auto Cleaning

- Press the  button on robot or press the  button on remote control to start auto cleaning.
- If the battery is low while the cleaning is not finished, the robot will return to the charging dock for charging.

Warm Tips: During the recharging process, there may be a phenomenon that the charging dock cannot be found. At this time, the robot will flash red light and “BEEP” four times. Please manually put the robot onto the charging dock to charge.

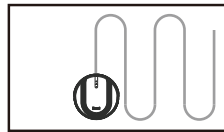
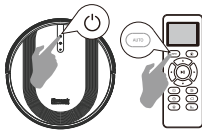

2. Spot Cleaning

When you select spot cleaning, robot intensely cleans a localized area by spiraling outward about 3 feet (1 meter) in diameter and then spiraling inward to where it started. When spot cleaning, robot boosts vacuum power to provide the best cleaning possible where you need it. To use spot cleaning, place robot on top of the localized debris and press  (Spot) on the remote control.

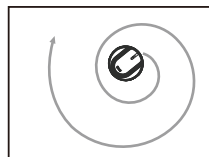

3. Power levels

1.When the robot vacuum cleaner is in sweeping mode, press this button to adjust the suction power; **2.**When the robot vacuum cleaner is in sweeping and mopping simultaneous mode, press this button to adjust the suction power; **3.**When the robot vacuum cleaner is in mopping mode, press this button to adjust the speed of the water output.

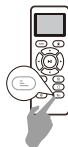

4. Edge Cleaning

After robot finishes cleaning the open areas of your floor, it uses edge clean to ensure that it has cleaned along walls and around furniture Legs. If you prefer a quicker edge cleaning, press the  button on remote control.

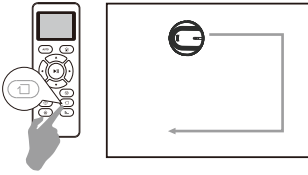

5. Single Room Cleaning

Press the button  on the remote control to start random cleaning.

Warm Tips: In this mode, the robot will keep cleaning for about 30 minutes and then stop. Please close the door to ensure the robot will not go out the room.

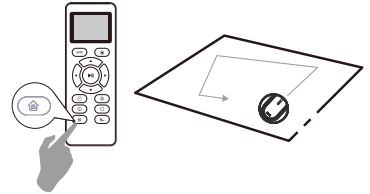

6. Floor Mopping Cleaning

Robot is equipped with a water tank so that it can clean your home in floor mopping cleaning mode.

- Attach the cloth and fill in the water tank with water.
- Remove the dust bin.
- Put the water tank back to robot and start the robot.

Note: If you are using a dry sweeping cleaning mode, skip the step of filling water.

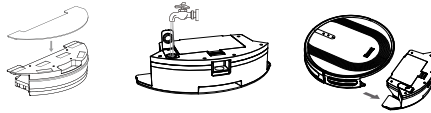

2.3 Cleaning Schedule



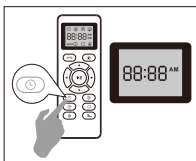

Robot has cleaning schedule settings which allow you to customize when Robot cleans your home.

1. Set the Remote Control's Clock

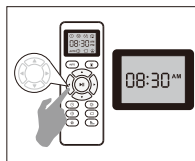

Press  button on remote control, and then the hour section begins to flash in the clock display setting window.



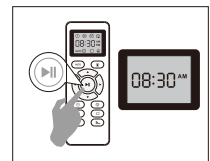

Press the  or  button to select the minute or hour section. Press  or  button to select the desired figures.





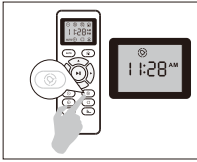

And then press the  button, the robot will “BEEP” when the clock setting completed.

2. Setting Cleaning Schedule

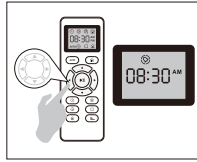

Press  button on remote control, and then the hour section begins to hash in the cleaning schedule display setting window.



Press the  or  button to select the minute or hour section. Press  or  button to select the desired figures.

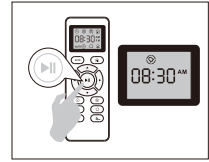

And then press the  button, the robot will “BEEP” when the cleaning schedule setting is completed.

3. Cancel the Cleaning Schedule

Press and hold  button approximately 4 seconds on remote control, the robot will “BEEP” when the cleaning schedule process is canceled.

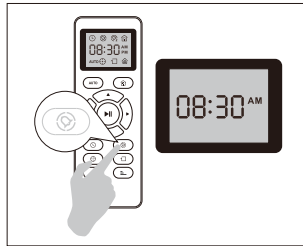

3. Regular Robot Care

To keep robot running at peak performance, perform the following care procedures. If you notice robot picking up less debris from your floor, then empty the bin, clean the filter and rolling brush.

Recommended cleaning /replacement frequency:

Robot part	Cleaning	Replacement frequency
Dust bin	After each use	---
Filters	Once every week	Every 2 months
Rolling brush	Once every week	Every 6-12 months

Side brushes	Once every month	Every 3-6 months (or when visibly worn)
Brush guard	Once every month	Every 3-6 months (or when the silicone rubber strip on the brush guard is visibly worn)
Sensors	Once every month	---
Charging pins	Once every month	---
Swivel wheel	Once every month	---

3.1 Empty Robot's Bin

1. Press bin release button to remove the bin.

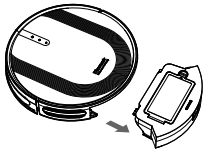

2. Open bin's door to empty it.



3.2 Clean Robot's Filter

1. Remove filter by grasping the white tab.

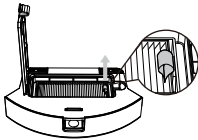

2. Shake off debris by tapping the filter against your trash container.



3.3 Clean Robot's Rolling Brush, Side Brush, Swivel Wheel and Sensors

1. Take out the rolling brush, clean the vacuuming aisle by a cloth.

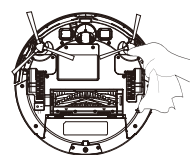
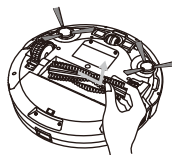
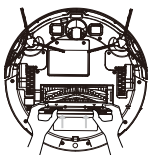

2. Clean the rolling brush. Cut down the hair winded in the rolling brush with the provided cleaning tool' s knife.

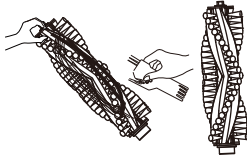

3. Remove the side brush, use a cloth to remove the dust from the brush.

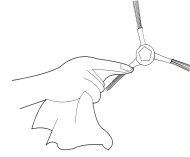

4. Pull out the swivel wheel, then clean the swivel wheel with the cleaning tool.

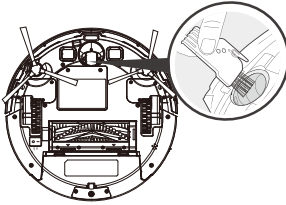

5. Dust off the cliff sensors to maintain the best performance.

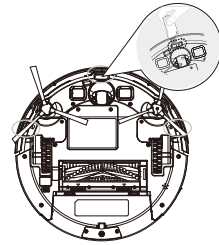

4. Troubleshooting

Robot will tell you something is wrong with a two-tone distress sound. The indicator will also blink or light red. Refer to the chart as below to resolve the robot' s problem. If the problem is not resolved, please contact our COST FREE customer service team for more assistance.

Warm Tips: For some errors, rebooting the robot may resolve the problem. To reboot the robot, press the power button on the bottom on robot, you will hear an audible tone signifying a successful reboot.

Robot blinks and says		Likely cause	What to do
Flash red indicator light	BEEP once	Gyroscope error.	Keep the robot at a stable place to restart and do not move the machine.
	BEEP twice	Bumper is stuck.	Check whether the bumper is flexible.
	BEEP triple	Robot's cliff sensors are dirty, it is hanging over a drop, or it is stuck on a dark surface.	If the robot is hanging over a drop, or on a dark surface, please start in a new location. Otherwise, wipe its cliff sensors with a dry cloth.
	BEEP quartic	Low power or charging error.	The voltage of robot is too low and needs manually charging.

5. FAQ

Problems	Solutions
Robot cannot be activated.	<ul style="list-style-type: none"> * Make sure the main power switch is in the ON position. * Make sure the battery is fully charged. * Replace the batteries (2*AAA) in the remote control. * Make sure the remote control is within range(16 ft/5 m) of robot. * If you still have trouble, turn off the main power switch and then turn it back on.
The remote control does not work.	<ul style="list-style-type: none"> * Replace the batteries in the remote control. * Make sure the robot is turned on and fully charged.
Robot stops working suddenly.	<ul style="list-style-type: none"> * Check if robot is trapped or stuck on an obstacle. * Check if the battery level is too low. * If you still have trouble, turn off the main power switch, wait for 2 seconds, and then turn it back on.
You can't schedule cleaning.	<ul style="list-style-type: none"> * Make sure the main power switch on the bottom of robot is turned on * Make sure the time, time of day (AM/PM), and the scheduled time have been set correctly. * Check if robot's power is too low to start cleaning.
Suction power is weak.	<ul style="list-style-type: none"> * Check if any obstructions are blocking the suction inlet * Empty the dust bin. * Clean the filters with a vacuum cleaner or a cleaning brush. * Check if the filters are wet due to water or other liquid on the floor. Air-dry the filters completely before use.
Robot can't be charged.	<ul style="list-style-type: none"> * Check if the indicator on the charging dock lights up. If not, contact the service center to repair or replace the charging dock. * Dust off the charging contact pins with a dry cloth. * Check if you can hear a beep when robot is return the charging dock. If not, contact the service center to repair or replace the charging dock.

<p>Robot can't return to the charging dock.</p>	<ul style="list-style-type: none"> * Remove objects within 3 ft/1 m to the left and right side and within 6 ft/2 m of the front of the charging dock. * When robot is in the vicinity of the charging dock, it will return more quickly. However, if the charging dock is located far away, the robot will need more time to return. Please be patient as it works its way back. * Clean the charging contact pins.
<p>The rolling brush doesn't rotate.</p>	<ul style="list-style-type: none"> * Clean the rolling brush. * Check if the rolling brush and brush guard have been installed properly.
<p>Robot movements or travel paths are abnormal.</p>	<ul style="list-style-type: none"> * Clean the sensors carefully with a dry cloth. * Restart robot by turning the power switch off and on.

AFTER-SALE SERVICE

Our customer service is friendly and hassle-free, please contact us if you need our help .